

**20V PNP HIGH GAIN TRANSISTOR IN SOT89**

**Features**

- $BV_{CEO} > -20V$
- High current capability Max Continuous Current  $I_C = -6A$
- Low saturation voltage  $V_{CE(sat)} < -47mV @ I_C = -1A$
- $R_{CE(sat)} = 28m\Omega$
- $P_D = 2.4W$
- Complementary part number ZXTN19020DZ
- **Lead Free, RoHS Compliant (Note 1)**
- **Halogen and Antimony Free, "Green" Device (Note 2)**
- **Qualified to AEC-Q101 Standards for High Reliability**

**Mechanical Data**

- Case: SOT89
- Moisture Sensitivity: Level 1 per J-STD-020
- UL Flammability Rating 94V-0
- Terminals: Matte Tin Finish
- Weight: 0.052 grams (Approximate)

**Application**

- Power disconnect switch
- Battery chargers
- High side drivers
- Motor drive

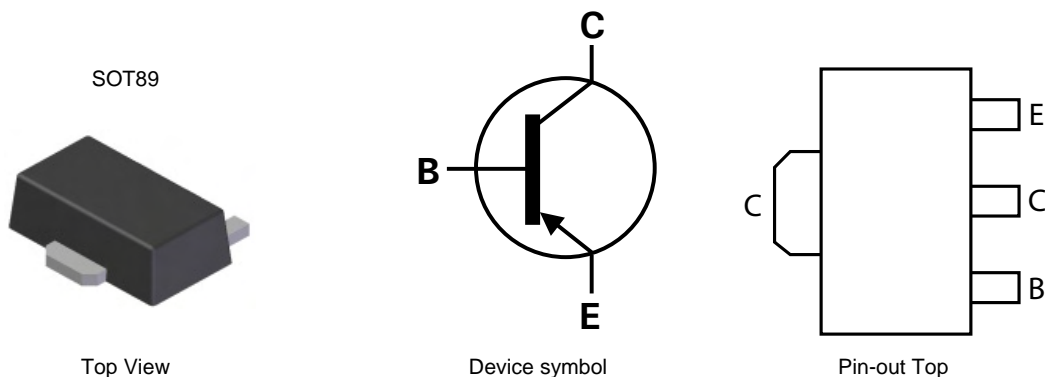

**Ordering Information** (Note 3)

Product	Marking	Reel size (inches)	Tape width (mm)	Quantity per reel
ZXTP19020DZTA	1M1	7	12	1,000

- Notes:
1. No purposefully added lead.
  2. Halogen and Antimony Free. Diodes Inc's "Green" Policy can be found on our website at <http://www.diodes.com>
  3. For packaging details, go to our website at <http://www.diodes.com>

**Marking Information**

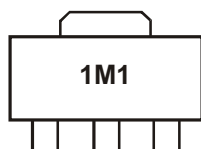

1M1 = Product Type Marking Code

**Maximum Ratings** @T<sub>A</sub> = 25°C unless otherwise specified

Characteristic	Symbol	Value	Unit
Collector-Base Voltage	V <sub>CB0</sub>	-25	V
Collector-Emitter Voltage	V <sub>CEO</sub>	-20	V
Emitter-Base Voltage	V <sub>ECO</sub>	-4	V
Emitter-Base Voltage	V <sub>EBO</sub>	-7	V
Continuous Collector Current (Note 6)	I <sub>C</sub>	-6	A
Base current	I <sub>B</sub>	-1	A
Peak Pulse Current	I <sub>CM</sub>	-15	A

**Thermal Characteristics** @T<sub>A</sub> = 25°C unless otherwise specified

Characteristic	Symbol	Value	Unit
Power Dissipation (Note 4)	P <sub>D</sub>	1.1	W
Linear derating factor		8.8	mW/°C
Power Dissipation (Note 5)	P <sub>D</sub>	1.8	W
Linear derating factor		14.4	mW/°C
Power Dissipation (Note 6)	P <sub>D</sub>	2.4	W
Linear derating factor		19.2	mW/°C
Power Dissipation (Note 7)	P <sub>D</sub>	4.46	W
Linear derating factor		35.7	mW/°C
Power Dissipation (Note 8)	P <sub>D</sub>	26.7	W
Linear derating factor		213	mW/°C
Thermal Resistance, Junction to Ambient (Note 4)	R <sub>θJA</sub>	117	°C/W
Thermal Resistance, Junction to Ambient (Note 5)	R <sub>θJA</sub>	68	°C/W
Thermal Resistance, Junction to Ambient (Note 6)	R <sub>θJA</sub>	51	°C/W
Thermal Resistance, Junction to Ambient (Note 7)	R <sub>θJA</sub>	117	°C/W
Thermal Resistance, Junction to Leads (Note 8)	R <sub>θJL</sub>	4.69	°C/W
Operating and Storage Temperature Range	T <sub>J</sub> , T <sub>STG</sub>	-55 to +150	°C

- Notes:
4. For a device surface mounted on 15mm x 15mm x 0.6mm FR4 PCB with high coverage of single sided 1oz copper, in still air conditions.
  5. Mounted on 25mm x 25mm x 0.6mm FR4 PCB with high coverage of single sided 1oz copper, in still air conditions.
  6. Mounted on 50mm x 50mm x 0.6mm FR4 PCB with high coverage of single sided 2oz copper, in still air conditions.
  7. As note 6 above measured at t<5 seconds.
  8. Junction to case (collector tab). Typical

**Thermal Characteristics**

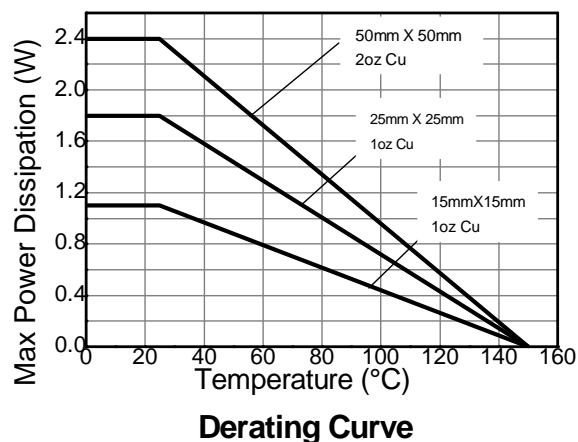
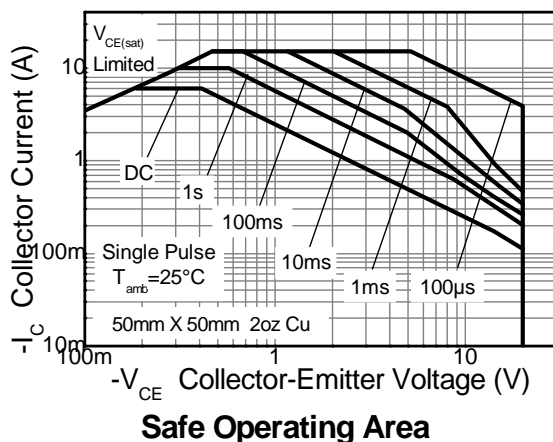

**Thermal Characteristics (- Continued)**

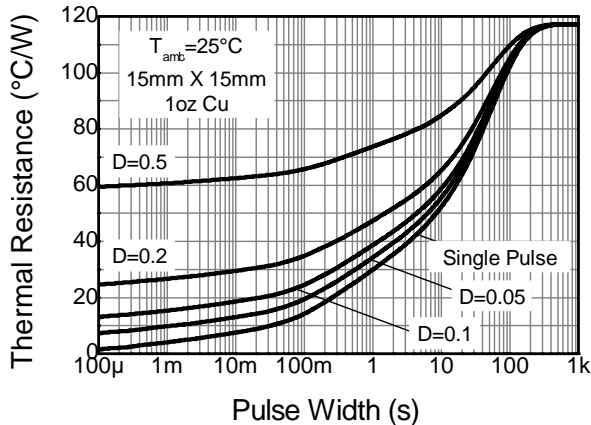

**Transient Thermal Impedance**

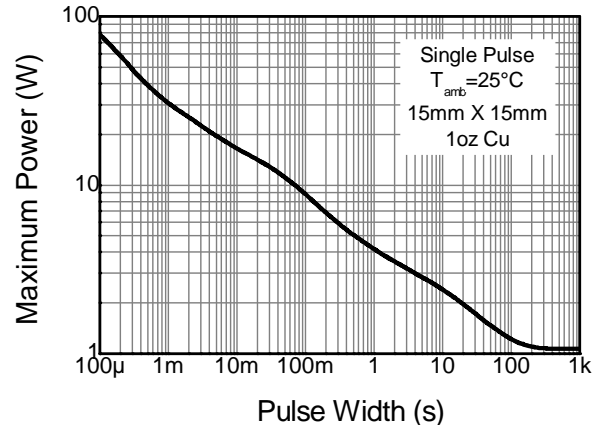

**Pulse Power Dissipation**

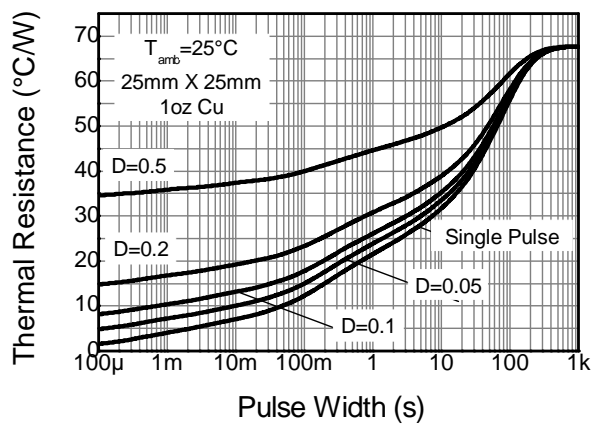

**Transient Thermal Impedance**

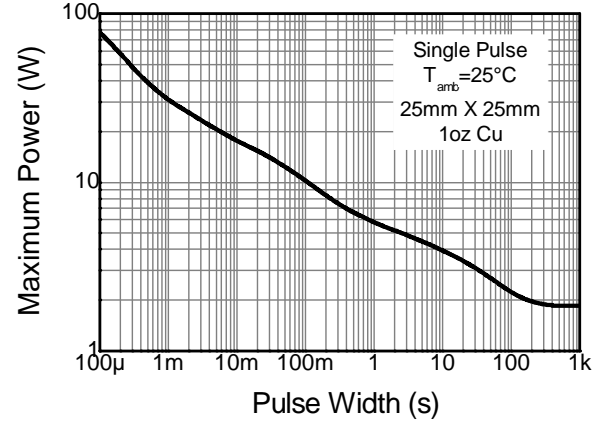

**Pulse Power Dissipation**

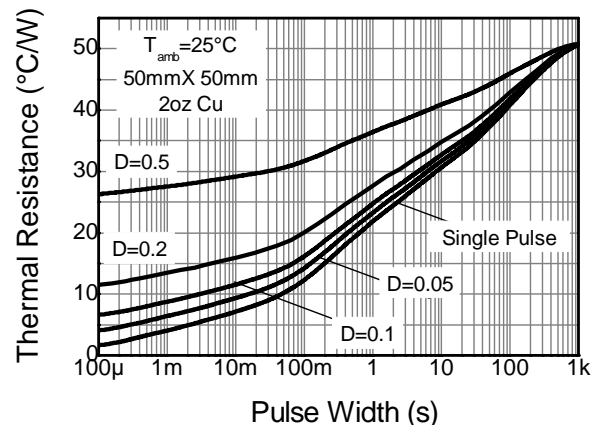

**Transient Thermal Impedance**

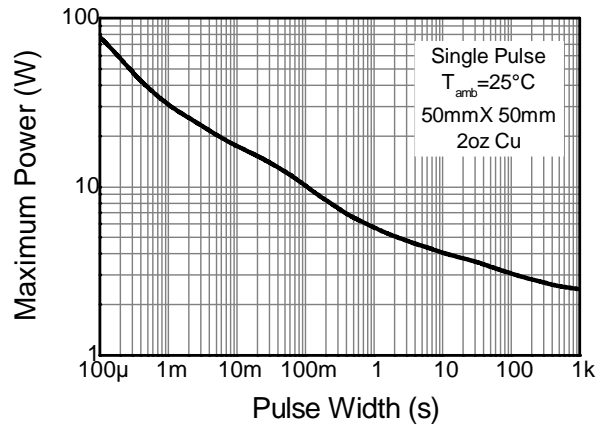

**Pulse Power Dissipation**

**Electrical Characteristics** @ $T_A = 25^\circ\text{C}$  unless otherwise specified

Characteristic	Symbol	Min	Typ.	Max	Unit	Test Condition
Collector-Base Breakdown Voltage	$BV_{CBO}$	-25	-55	-	V	$I_C = -100\mu\text{A}$
Collector-Emitter Breakdown Voltage (Notes 9)	$BV_{CEO}$	-20	-50	-	V	$I_C = -10\text{mA}$
Emitter-Collector breakdown voltage (reverse blocking)	$BV_{ECX}$	-4	-8.6	-	V	$I_E = -100\mu\text{A}$ , $R_{BC} < 1\text{k}\Omega$ or $0.25\text{V} > V_{BC} > -0.25\text{V}$
Emitter-Collector breakdown voltage (reverse blocking)	$BV_{ECO}$	-4	-8.6	-	V	$I_E = -100\mu\text{A}$
Emitter-Base Breakdown Voltage	$BV_{EBO}$	-7	-8.2	-	V	$I_E = -100\mu\text{A}$
Collector Cutoff Current	$I_{CBO}$	-	< -1	-50	nA	$V_{CB} = -25\text{V}$
		-	-	-500		$V_{CB} = -25\text{V}$ , $T_A = 100^\circ\text{C}$
Emitter Cutoff Current	$I_{EBO}$	-	< -1	-50	nA	$V_{EB} = -5.6\text{V}$
DC current transfer Static ratio (Notes 9)	$h_{FE}$	300	450	900	-	$I_C = -100\text{mA}$ , $V_{CE} = -2\text{V}$
		200	290	-		$I_C = -2\text{A}$ , $V_{CE} = -2\text{V}$
		65	110	-		$I_C = -6\text{A}$ , $V_{CE} = -2\text{V}$
		-	25	-		$I_C = -15\text{A}$ , $V_{CE} = -2\text{V}$
Collector-Emitter Saturation Voltage (Notes 9)	$V_{CE(sat)}$	-	-40	-47	mV	$I_C = -1\text{A}$ , $I_B = -100\text{mA}$
		-	-100	-130		$I_C = -1\text{A}$ , $I_B = -10\text{mA}$
		-	-115	-145		$I_C = -2\text{A}$ , $I_B = -40\text{mA}$
		-	-225	-275		$I_C = -6\text{A}$ , $I_B = -300\text{mA}$
Base-Emitter Saturation Voltage (Notes 9)	$V_{BE(sat)}$	-	-1000	-1100	mV	$I_C = -6\text{A}$ , $I_B = -300\text{mA}$
Base-Emitter Turn-on Voltage (Notes 9)	$V_{BE(on)}$	-	-865	-1000	mV	$I_C = -6\text{A}$ , $V_{CE} = -2\text{V}$
Transitional Frequency (Notes 9)	$f_T$	-	176	-	MHz	$I_C = -50\text{mA}$ , $V_{CE} = -10\text{V}$ , $f = 50\text{MHz}$
Input Capacitance	$C_{ibo}$	-	-	400	pF	$V_{EB} = -0.5\text{V}$ , $f = 1\text{MHz}$
Output capacitance	$C_{obo}$	-	36	45	pF	$V_{CB} = -10\text{V}$ , $f = 1\text{MHz}$
Delay time	$t_d$	-	23	-	ns	$V_{CC} = -10\text{V}$ , $I_C = -1\text{A}$ , $I_{B1} = -I_{B2} = -50\text{mA}$
Rise time	$t_r$	-	18.4	-	ns	
Storage time	$t_s$	-	266	-	ns	
Fall time	$t_f$	-	49.6	-	ns	

Notes: 9. Measured under pulsed conditions. Pulse width  $\leq 300\mu\text{s}$ . Duty cycle  $\leq 2\%$ .

**Typical Electrical Characteristics**

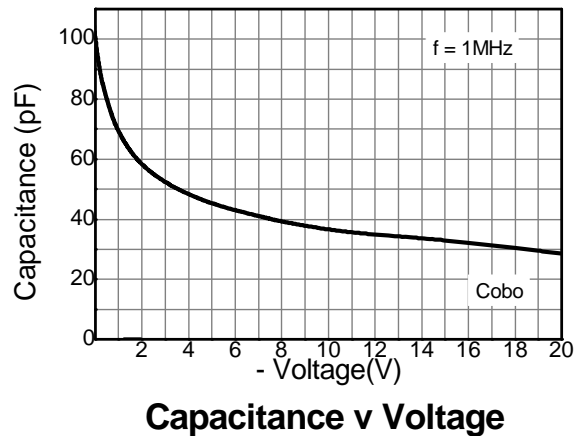
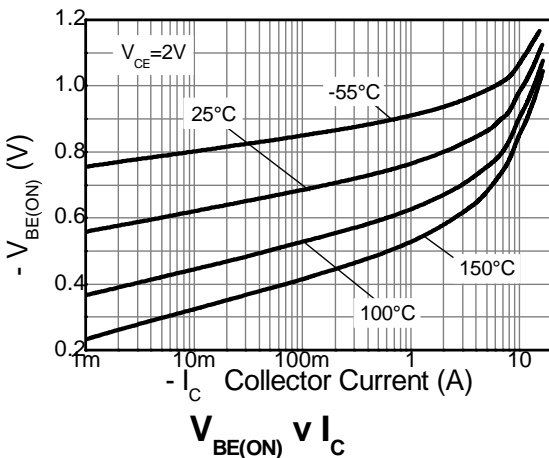
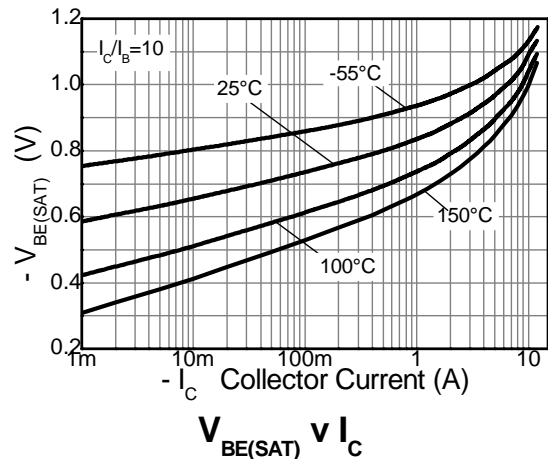
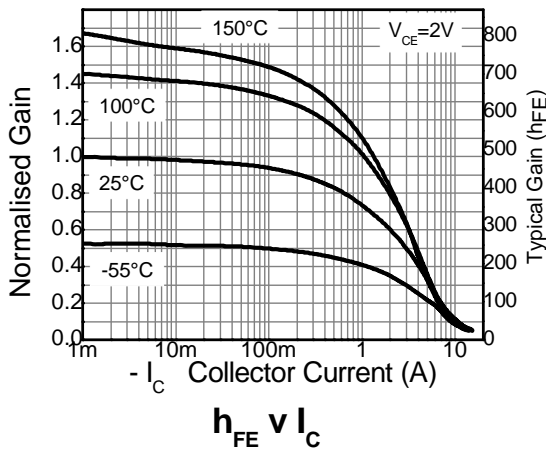
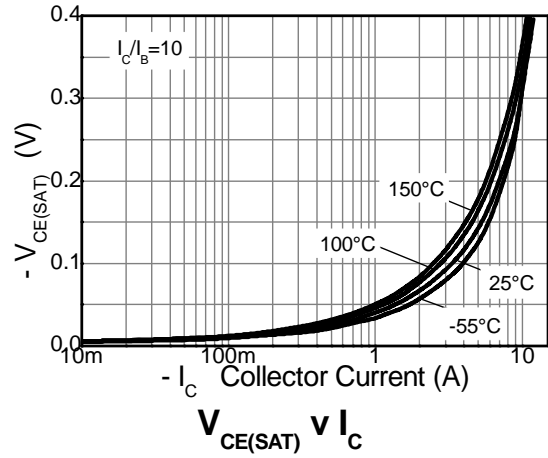
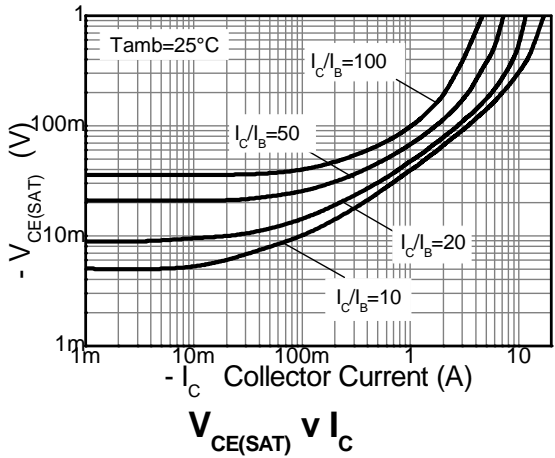

**Package Outline Dimensions**

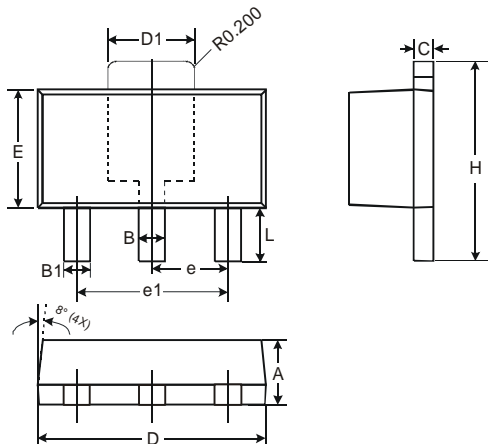

SOT89		
Dim	Min	Max
A	1.40	1.60
B	0.44	0.62
B1	0.35	0.54
C	0.35	0.43
D	4.40	4.60
D1	1.52	1.83
E	2.29	2.60
e	1.50 Typ	
e1	3.00 Typ	
H	3.94	4.25
L	0.89	1.20
All Dimensions in mm		

**Suggested Pad Layout**

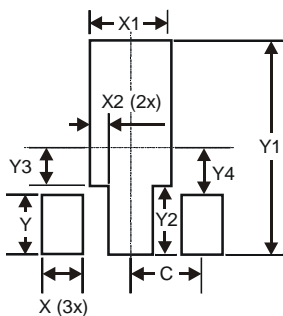

Dimensions	Value (in mm)
X	0.900
X1	1.733
X2	0.416
Y	1.300
Y1	4.600
Y2	1.475
Y3	0.950
Y4	1.125
C	1.500

**IMPORTANT NOTICE**

DIODES INCORPORATED MAKES NO WARRANTY OF ANY KIND, EXPRESS OR IMPLIED, WITH REGARDS TO THIS DOCUMENT, INCLUDING, BUT NOT LIMITED TO, THE IMPLIED WARRANTIES OF MERCHANTABILITY AND FITNESS FOR A PARTICULAR PURPOSE (AND THEIR EQUIVALENTS UNDER THE LAWS OF ANY JURISDICTION).

Diodes Incorporated and its subsidiaries reserve the right to make modifications, enhancements, improvements, corrections or other changes without further notice to this document and any product described herein. Diodes Incorporated does not assume any liability arising out of the application or use of this document or any product described herein; neither does Diodes Incorporated convey any license under its patent or trademark rights, nor the rights of others. Any Customer or user of this document or products described herein in such applications shall assume all risks of such use and will agree to hold Diodes Incorporated and all the companies whose products are represented on Diodes Incorporated website, harmless against all damages.

Diodes Incorporated does not warrant or accept any liability whatsoever in respect of any products purchased through unauthorized sales channel. Should Customers purchase or use Diodes Incorporated products for any unintended or unauthorized application, Customers shall indemnify and hold Diodes Incorporated and its representatives harmless against all claims, damages, expenses, and attorney fees arising out of, directly or indirectly, any claim of personal injury or death associated with such unintended or unauthorized application.

Products described herein may be covered by one or more United States, international or foreign patents pending. Product names and markings noted herein may also be covered by one or more United States, international or foreign trademarks.

**LIFE SUPPORT**

Diodes Incorporated products are specifically not authorized for use as critical components in life support devices or systems without the express written approval of the Chief Executive Officer of Diodes Incorporated. As used herein:

A. Life support devices or systems are devices or systems which:

1. are intended to implant into the body, or
2. support or sustain life and whose failure to perform when properly used in accordance with instructions for use provided in the labeling can be reasonably expected to result in significant injury to the user.

B. A critical component is any component in a life support device or system whose failure to perform can be reasonably expected to cause the failure of the life support device or to affect its safety or effectiveness.

Customers represent that they have all necessary expertise in the safety and regulatory ramifications of their life support devices or systems, and acknowledge and agree that they are solely responsible for all legal, regulatory and safety-related requirements concerning their products and any use of Diodes Incorporated products in such safety-critical, life support devices or systems, notwithstanding any devices- or systems-related information or support that may be provided by Diodes Incorporated. Further, Customers must fully indemnify Diodes Incorporated and its representatives against any damages arising out of the use of Diodes Incorporated products in such safety-critical, life support devices or systems.

Copyright © 2011, Diodes Incorporated

[www.diodes.com](http://www.diodes.com)